

> PORTX[®] DAVIT



This product is patented

MATERIALS
Handling *Working with ease...*
PTY LTD

Our lightweight and portable **PORTX[®] DAVIT** has been designed and specified for fall protection applications including confined space access and egress, with the added benefit of goods lifting capability.

Very well suited to a wide range of industrial and construction safety applications, including shoring/trenching and confined space access. Fall protection devices are mounted on the rear of the column to avoid clashes with guardrails, walls or similar.

Key features

- Conforms with EN795:2012 Anchor Devices (class B) and tested as a complete safety system including brackets to EN1496:2017
- ATEX Zone 2 certification as standard
- ATEX Zone 1 optional upgrade
- Can support goods lifting up to 300kg and personnel lifting up to 150kg
- 3-piece design for ease of transportation and storage and comes with a carry bag
- Ability to locate two safety or lifting devices on the rear column of the davit, enabling primary and secondary safety or a combination of personnel and goods lifting
- Variable bracket mounting positions for better ergonomics
- Additional fall protection anchor on column for the winch operator
- Comfortable rotation under load due to Reid's patented integral bearing system
- Universal kingpin fits all Reid sockets and Portabases
- Manufactured from marine grade alloy, anodised/powder coated for high corrosion resistance
- Designed and built using quality engineering and production parts that help reduce weight and provide high strength to weight ratios.
- Can be assembled and operated by one person with no tools required

Accessories

REID offer a range of winch and retrieval fall arrest connection brackets for the industries leading models, all tested and certified to EN795 and EN1496 to provide our customers with complete system confidence. See more details on page 3.



**300KG
WLL**



**1-2 PERSON
ASSEMBLY**



**CUSTOMISED
& BAGGED**



**EN795
CERTIFIED**



**ATEX
CERTIFIED**

Features & Performance

	2000	2400	2800
Accreditations, Certifications & Standards			
EN795:2012	✓	✓	✓
EN1496:2017	✓	✓	✓
ATEX Certified [Zone 2]	✓	✓	✓
ATEX Certified [Zone 1]	Optional	Optional	Optional
Capacity			
Maximum Goods Lifting [kg]	300	300	300
Maximum Personnel Lifting [kg]	150	150	150
Fall Arrest [Persons]	1	1	1
Dimensions			
Maximum Reach [mm]	800	800	800
Maximum Height of Lift [mm]	2000	2400	2800
Socket Details			
Ø 65mm	✓	✓	✓
Top Mount	✓	✓	✓
Flush Mount	✓	✓	✓
Side Mount	✓	✓	✓
Bridge Mount	✓	✓	✓
Pedestal	✓	✓	✓
PortX Saddle Mount	✓	✓	✓
Porta Base	✓	✓	✓
Standard Features			
Winch Capable	✓	✓	✓
Component Weight < 15kg	✓	✓	✓
Finishes			
Anodised	✓	✓	✓
316SS Fixings	Optional	Optional	Optional
Marine Spec	Optional	Optional	Optional

PORTX® DAVIT

- A** Radius
- B** Overall height of lift
- C** Height to top of beam

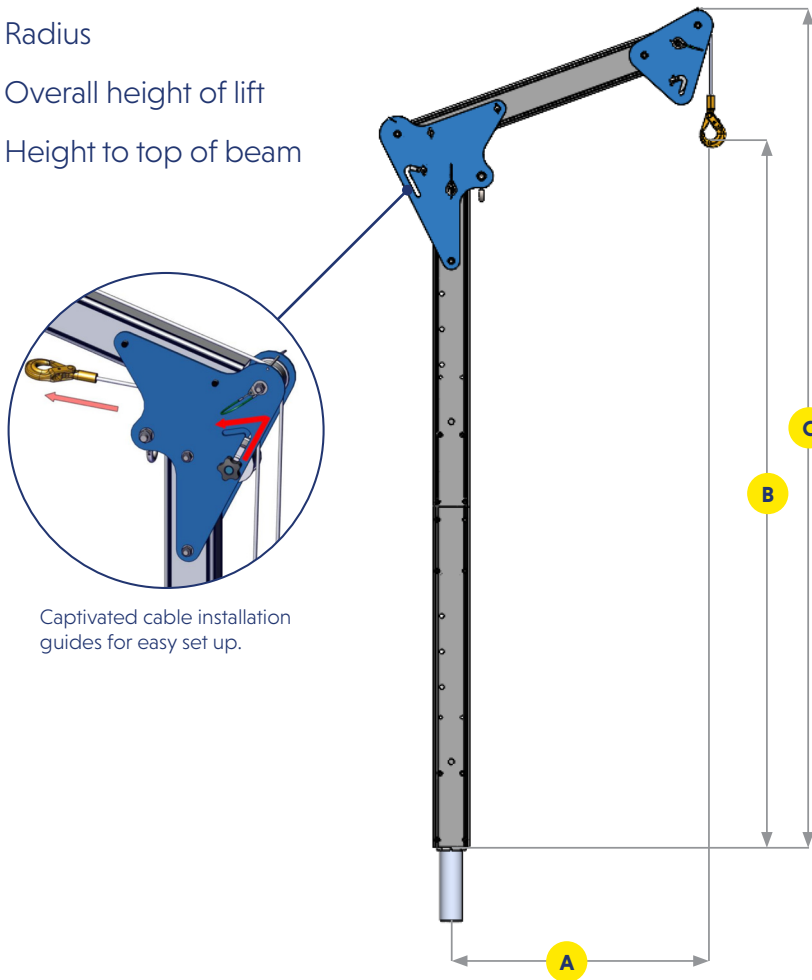

Model	Max User Weight [kg]	Max goods weight [kg]	Dimensions [mm]		
			A	B	C
PTXDR800-20	150	300	800	2000	2371
PTXDR800-24	150	300	800	2400	2771
PTXDR800-28	150	300	800	2800	3171

Winch & SRL Device Brackets

We offer a wide range of winch brackets for common goods and personnel winches as well as the equivalent for Safety Retrieval Lifeline Devices. The winch brackets can be attached to each Davit to support the application required. Operations & Assembly instructions can be found for each device on our website.

Personnel Winches		
Supported Device	Product Code (Single Winch)	Product Code (Double Winch)
G.Winch	RAWB005200	RAWB005209
Guardian Checkmate	RAWB001200	RAWB001209
IKAR PLW	RAWB004200	RAWB004209
MSA Workman	RAWB008000	N/A
3M SALA Winch	RAWB003000	RAWB003009
3M DBI SALA Digital Winch	RAWB003000	RAWB003009
Tuffbuilt Pro Series 1	RAWB009200	N/A
Tuffbuilt Pro Series 2	RAWB009300	N/A

SRL Devices	
Supported Device	Product Code
Guardian FABXR	RAWB001000
Tractel Blocfor	RAWB002000
3M Rebel Protect A	RAWB003000
SALA Sealed Block	RAWB003000
3M Sala Ultra-Lok	RAWB003000
IKAR HRA	RAWB004000
Globestock G-Saver GSE 414G	RAWB005500
Globestock G-Saver GSE 420G	RAWB005000
Globestock G-Saver GSE 434G	RAWB005000
Ridgegear	RAWB006000
MSA Rescuer	RAWB008000

> Suitable for use with the following PORTABASE® Systems and sockets

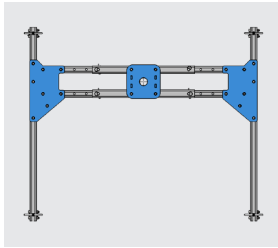

PORTABASE® H Base

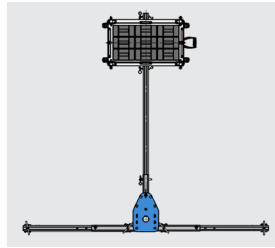

PORTABASE® Counterbalance

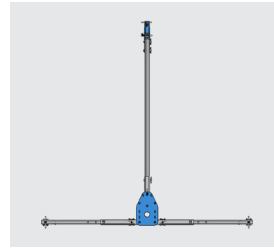

PORTABASE® Trailer Hitch

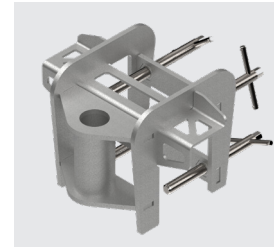

PORTX® Saddle Mount Socket

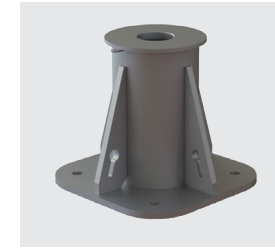

Top Mount Socket



Flush Mount Socket

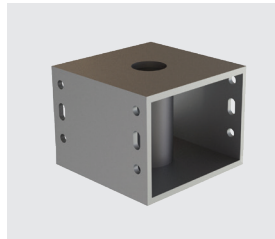

Bridge Mount Socket

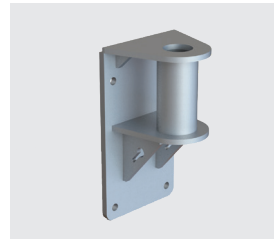

Side Mount Socket

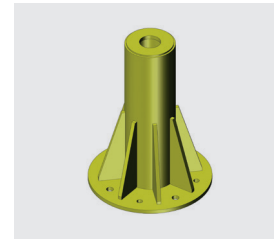

Socket Pedestals